

Wheel Features

Tread Material:	PU	Core Material:	Cast Iron
Bearing:	Ball Bearing	Tread Hardness:	95A±3
Temperature:	-25°C~60°C	Running Speed:	4km/h

Note: Use beyond temperature range or beyond the recommended speed may shorten product life or even damage the product.



- ✔ 2 precision ball bearings, flexible rotation
- ✔ Polyurethane on casting iron core, high load capacity, wear resistance, oil resistance
- ✔ Environmental protection, quiet, effectively protect the floor
- ✔ Painted, anti-rust and anti-corrosion
- ⚠ High temperature and humidity may shortened service life



Rolling resistance	■ ■ ■ ■ □	Very good
Wear resistance	■ ■ ■ ■ ■	Excellent
Operating noise	■ ■ ■ ■ □	Very good
Floor surface preservation	■ ■ ■ ■ □	Very good

Bracket Features





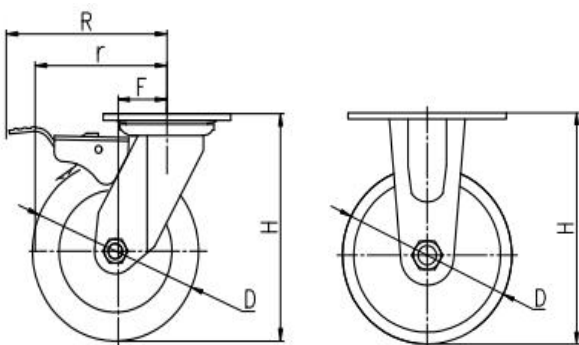

- ✔ Steel plate pressed and welded, firm and strong
- ✔ Reinforced riveted, close gap, high structural strength
- ✔ Blue galvanized, ROHS/REACH passed, salt spray test over 72 hours
- ✔ Easy to operate, convenient to release the brake
- ✔ Dustproof ring effectively protects grease for long service life

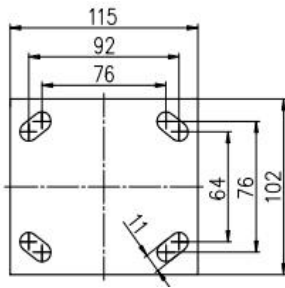
Parameter (mm)	Capacity KG	Wheel Dia.	Wheel Width	Total Height	Offset	Swivel Radius	Swivel Radius
5"	270 kg	125	43	165	38	101	149
6"	310 kg	150	45	190	44	119	150
8"	360 kg	200	45	240	54	154	163



Mounting Drawing



Product ID						
Wheel Size	Plate swivel	Plate fixed	Plate swivel brake	Plate swivel brake	Plate swivel brake	Plate swivel brake
5"	35C05-1683	35C08-1683	35C21-1683	35C66-1683	35C07-1683	35C57-1683
6"	35C09-1684	35C12-1684	35C22-1684	35C67-1684	35C11-1684	35C58-1684
8"	35C13-1685	35C16-1685	35C23-1685	35C68-1685	35C15-1685	35C59-1685

Product Details

Fancy riveting has tight clearance, the structure is stable and high strength.



Dust ring can effectively protect dust and grease lubrication.



The surface treatment of bracket is Zinc plated, blue, which can meet the salt spray test for 72 hours. The bracket is curved shape, nice appearance and high strength.



Arc wheel moving easily. Iron cover looks nice and anti-winding.



[English]

